



Alu-Bast

The Alu-Bast collection by ONE A is a modular system, which can be assembled in various constellations.

The collection consists of two main components, respectively in aluminium and alabaster, both available in different lengths.

An elegant soft light is emitted through the alabaster stone, creating a cozy atmosphere.

SURFACE MOUNTED TUBE

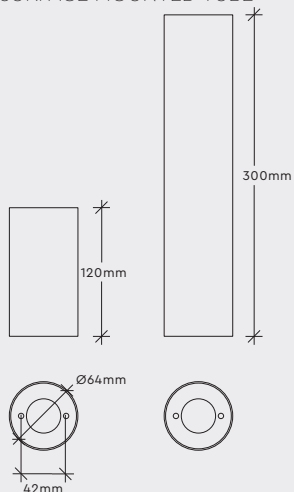

ALUBASTER

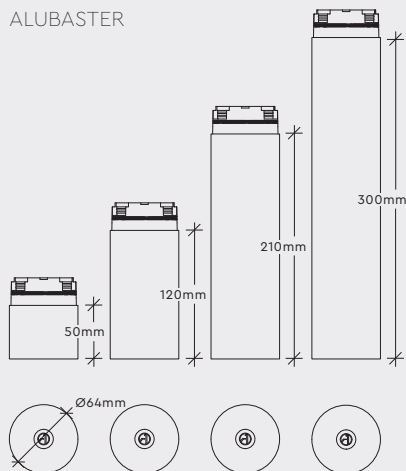

The crossed-out wheeled bin symbol indicates that the item should be disposed of separately from household waste. The item should be handed in for recycling in accordance with local environmental regulations for waste disposal. By separating a marked item from household waste, you will help reduce the volume of waste sent to incinerators or land-fill and minimize any potential negative impact on human health and the environment.

ALU-BAST 230V – SURFACE

DATA

Collection	ONE A
Product	ALU-BAST
Article no.	1A13.4591.xx65 (S120, Alubaster 50) 1A13.4592.xx65 (S120, Alubaster 120) 1A13.4593.xx65 (S120, Alubaster 210) 1A13.4594.xx65 (S120, Alubaster 300) 1A13.4691.xx65 (S300, Alubaster 50) 1A13.4692.xx65 (S300, Alubaster 120) 1A13.4693.xx65 (S300, Alubaster 210) 1A13.4694.xx65 (S300, Alubaster 300)

SPECIFICATIONS

Weight	0.78kg – 2.4kg
Material	Aluminium, Alabaster
Power	5W
Voltage	AC200 – 240V 50/60Hz
IP protection grade	IP20
LED	BRIDGELUX COB LED (light source included)
CCT	2500K (Due to alabast – variations will occur)
Lumen	100–200lm
Efficiency	35–40lm/W
CRI	90+
Dimmable	Yes
Lifespan	>40.000Hrs
Labelling	CE
Insulation class	Class II

IES/LDT Energy Classifications For IES/LDT lux files review – LUX FILES [➤](#)



ONE A
1AL.19.27.15



5.5W
kWh/1000h

Dimmer	Driver code	A		B		C		D		E		F		G							
		VADSBO		VD200		NIKO (310-016)		BUSCH (6523U)		OPUS (T39-01)		OPUS (39-07)		OPUS (T39-08)		OPUS (T46-03)					
		Result	P _{max}	P _{min}	Result	P _{max}	P _{min}	Result	P _{max}	P _{min}	Result	P _{max}	P _{min}	Result	P _{max}	P _{min}					
1AL.19.27.15	200V	5.121	0.512	✓	4.993	0.853	✓	5.207	turn off	✓	5.207	0.853	✓	5.164	0.725	✓	5.249	0.64	✓	5.292	2.006
	240V	5.804	0.788	✓	6.103	1.835	✓	6.316	turn off	✓	6.7	1.237	✓	6.658	1.067	✓	6.572	0.939	small flash at the high point	5.633	2.859
	264V	5.804	0.939	✓	6.487	3.414	✓	6.487	0.811	✓	6.828	1.494	✓	6.786	1.28	✓	6.7	1.109	small flash at the high point	5.761	3.414

XX – COLOUR CODES

	01 – White		97 – Gold
	53 – Elephant Grey <i>cross-brushed</i>		98 – Silver
	92 – Black Pearl		99 – Bronze

IMPORTANT INFORMATION

Installation and mounting must be performed by a certified electrician only, and instructions must be followed.

CLEANING AND MAINTENANCE:

Use a soft moist cloth for cleaning. No further maintenance is required.

WARRANTY:

If the product is defect, please contact your supplier immediately. Please note that warranty will not apply in case of wrongful use or if unskilled personnel attempts to repair.

COMPONENTS

- AluBast
- light source

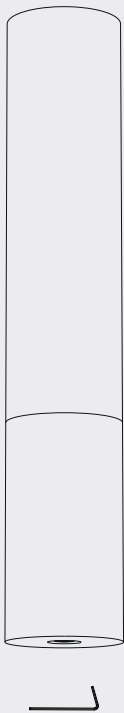

ALU-BAST SURFACE

ASSEMBLY INSTRUCTION

STEP 1

Mount the fixture onto the ceiling, by placing the Base over the screws and slightly rotating, then tighten the screws.

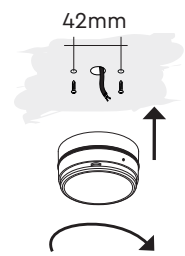

STEP 2

Connect the wires.

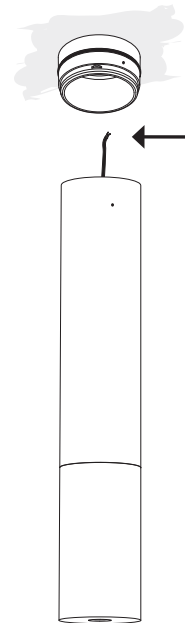

STEP 3

Mount the Tube onto the Base, by gently rotating until the allen screw aligns with the hole in the tube.

To secure the tube in place, turn the allen screw anti-clockwise until the screw is flush with the tube.

NOTE: When rotating the fixture choose the direction with the least resistance.

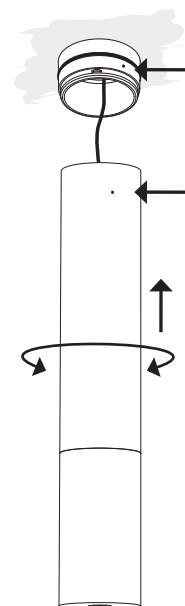

ALU-BAST SURFACE

INSTRUCTIONS TO CHANGE LIGHT SOURCE

STEP 1

To remove Alabaster Part:

1. With the accompanying allen key turn the screw clockwise until the Alabaster part can rotate
2. Take hold of the Alabaster part, then gently pull down, whilst slightly rotating

NOTE: When rotating the fixture choose the direction with the least resistance.

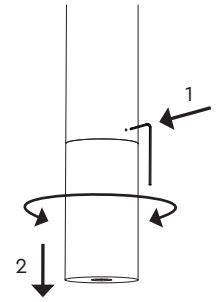

STEP 2

1. Turn the 3 screws anti-clockwise using the allen key.
2. Remove the retaining ring using light pressure.

Then replace the light source, reattach the retaining ring, make sure it snaps. Finally, fasten the 3 screws, so that they are flush with the fixture ring.

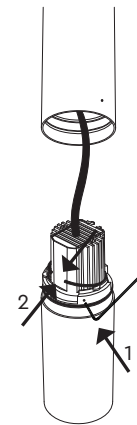

STEP 3

1. Remount the Alabaster part in the Tube, by gently rotating until the allen screw aligns with the hole in the Tube.
2. Secure the Alabaster part in place by turning the screw anti-clockwise until the screw is flush with the tube.

NOTE: When rotating the fixture choose the direction with the least resistance.

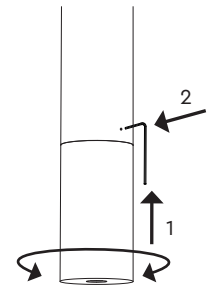

IMPORTANT INFORMATION

Disassembly must be performed by a certified electrician only, and instructions must be followed.

WARRANTY:

If the product is defect, please contact your supplier immediately. Please note that warranty will not apply in case of wrongful use or if unskilled personnel attempts to repair.

ALU-BAST SURFACE

DISASSEMBLY INSTRUCTION

STEP 1

To dismantle, turn the screw clockwise with the accompanying allen key, until the tube is able to rotate. Then gently pull down on the Tube, whilst slightly rotating.

NOTE: When rotating the fixture choose the direction with the least resistance.

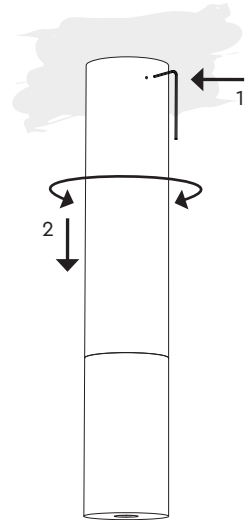

STEP 2

Disconnect the wires.

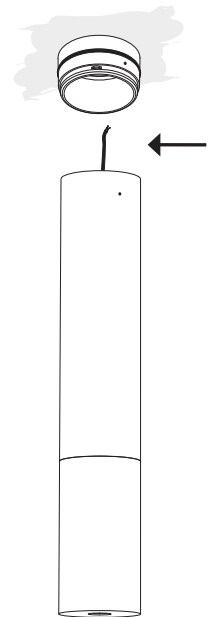

STEP 3

Loosen the screws, then slightly rotate and gently pull down.

