



ALUBASTER DIRECT Pendant datasheet



Project: Drewsen spisehus | Lighting Design: ONE A

The Alubaster Direct collection by ONE A is a modular system, which can be assembled in various constellations.

The collection consists of three main components, respectively in aluminium and alabaster, available in different lengths.

GENERAL DATA

Collection

ONE A

Product

Alabaster Direct – pendant

Article no.

- 1A13.5392.xx65
(Tube 300/120, Alabaster 120)
- 1A13.5393.xx65
(Tube 300/120, Alabaster 210)
- 1A13.5394.xx65
(Tube 300/120, Alabaster 300)
- 1A13.5492.xx65
(Tube 300/300, Alabaster 120)
- 1A13.5493.xx65
(Tube 300/300, Alabaster 210)
- 1A13.5494.xx65
(Tube 300/300, Alabaster 300)

SPECIFICATIONS

Weight

1.935 kg / 3 kg (alu)

3.39 kg / 5.12 kg (brass)

Material

Aluminium / Brass
and Alabaster

IP protection grade

IP20

Labelling

CE

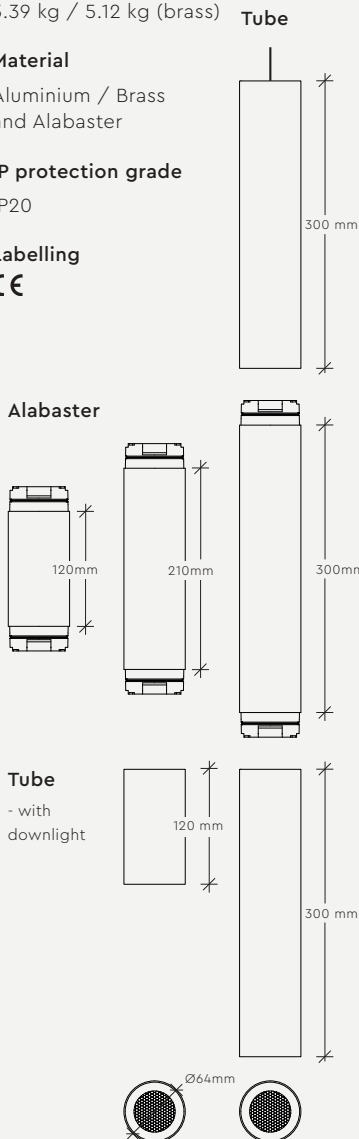

ONE A reserves the rights to change and/or update product information and accepts no liability for any printing errors.

last updated 22 - 01 - 2024

MAINS POWERED – ELECTRICAL SPECIFICATION

1A13.5X9X.xx65 – 230V

Light Source	BRIDGELUX COB LED (included)
Supply	14W (6W Alabaster + 8W downlight) AC200-240V 50/60Hz
CCT	2700K (nature stone – variations will occur!)
Lumen	Alabaster: 100-200 lm Downlight: 65 1lm
Efficiency	Alabaster: 35-40 lm/W Downlight: 89 lm/W
CRI	90+
Insulation class	Class II
Dimmable	Triac dimmable



Driver code	Dimmer	A		B		C		D		E		F		G								
		VADSBO	VD200	NIKO (310-016)	BUSCH (6523U)	OPUS (T39.01)	OPUS (39.07)	OPUS (T39.08)	OPUS (T46.03)													
1AL.19.27.15	200V	Result	P _{max}	P _{min}	Result	P _{max}	P _{min}	Result	P _{max}	P _{min}	Result	P _{max}	P _{min}	Result	P _{max}	P _{min}						
	240V	small flash at the low points	5.121	0.512	✓	4.993	0.853	✓	5.207	TURN OFF	✓	5.207	0.853	✓	5.164	0.725	✓	5.249	0.64	✓	5.292	2.006
	264V	small flash at the high points	5.804	0.768	✓	6.103	1.835	✓	6.316	TURN OFF	✓	6.7	1.237	✓	6.658	1.067	✓	6.572	0.939	✓	6.633	2.859
			5.804	0.939	✓	6.487	3.414	✓	6.487	0.811	✓	6.828	1.494	✓	6.786	1.28	✓	6.7	1.109	✓	5.761	3.414

NOTE:

3m cord included.

Due to pendant weight, AluBast pendants are delivered including a metal wire. The metal wire can be fixed to Storm Output – see technical info for more information.

OPTIONAL ACCESSORIES:

Output (not in combination with Canopy)

Storm Small Output – 1A00.0500.xx

Storm Medium Output – 1A01.0500.xx

If Storm Medium/Small Output is used the included metal suspension wire is not to be used

Suspension wire can be mounted in Storm Output, for further information refer to Storm Output's technical information.

Feed the accompanying steel wire through the small hole in Storm Output, then fasten the screw

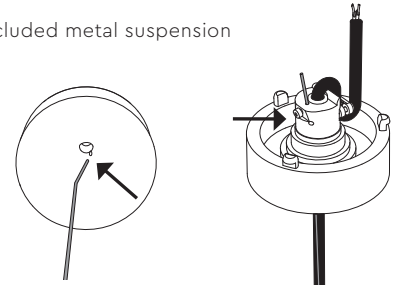

XX – COLOUR CODES

	01 – white grey textile cable		99 – bronze grey textile cable
	92 – black pearl grey textile cable		33 – nature* grey textile cable
	53 – elephant grey grey textile cable		34 – antique* grey textile cable
	97 – gold grey textile cable		35 – night* grey textile cable
	98 – silver grey textile cable		

(*) Brass is a natural product and colour will change over time

ASSEMBLY INSTRUCTION

Wire suspension assembly instruction

STEP 1

Mount the wire suspension to the ceiling with a screw.
Make sure to fasten screw into solid material which can withstand the fixtures weight

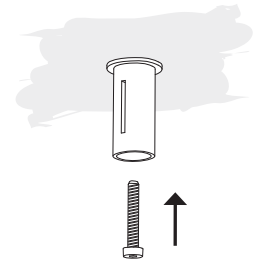

STEP 2

Mount the wire lock in the wire suspension.

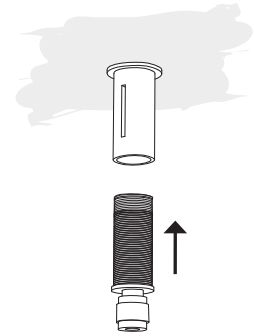

STEP 3

Guide the wire through the wire lock

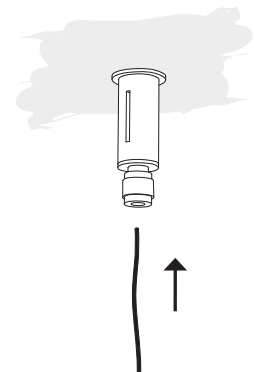

STEP 4

Then pull the wire out through the slot.
After height adjustments, make sure to lock the position by fastening the nut.

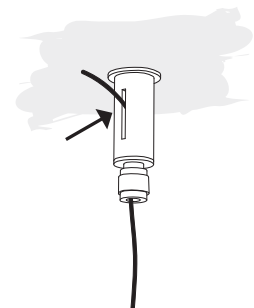

IMPORTANT INFORMATION

Installation and mounting must be performed by a certified electrician only, and instructions must be followed. Always make sure the main power is off during installation. Pay attention to the fixture remarks, and always make sure to use the correct voltage.

CLEANING AND MAINTENANCE:

Use a soft moist cloth for cleaning. No further maintenance is required.

WARRANTY:

If the product is defect, please contact your supplier immediately. Please note that warranty will not apply in case of wrongful use or if unskilled personnel attempts to repair.



The crossed-out wheeled bin symbol indicates that the item should be disposed of separately from household waste. The item should be handed in for recycling in accordance with local environmental regulations for waste disposal

For more information, please contact info@onea.dk

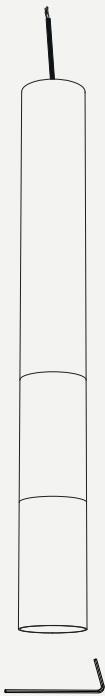

COMPONENTS

- Alubaster Direct
 - wire
 - light source
 - allen key

IMPORTANT INFORMATION

Installation and mounting must be performed by a certified electrician only, and instructions must be followed. Always make sure the main power is off during installation. Pay attention to the fixture remarks, and always make sure to use the correct voltage.

CLEANING AND MAINTENANCE:

Use a soft moist cloth for cleaning. No further maintenance is required.

WARRANTY:

If the product is defect, please contact your supplier immediately. Please note that warranty will not apply in case of wrongful use or if unskilled personnel attempts to repair.



The crossed-out wheeled bin symbol indicates that the item should be disposed of separately from household waste. The item should be handed in for recycling in accordance with local environmental regulations for waste disposal

For more information, please contact info@onea.dk

ASSEMBLY INSTRUCTION

Page 1 of 3

Ceiling attachment:

Please refer to chosen outlet installation manual.

STEP 1

Connect the cables.

Make sure to obtain cable strain relief, check power outlet for instructions.

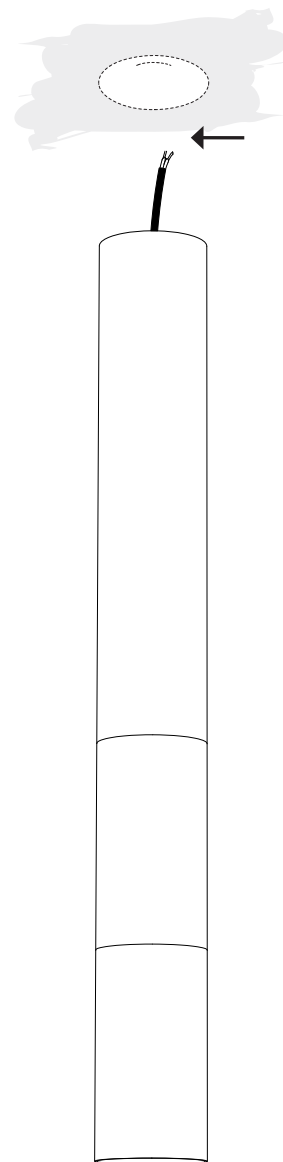
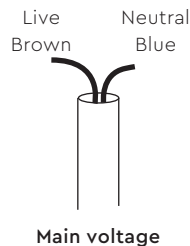

ASSEMBLY INSTRUCTION

Page 2 of 3

INSTRUCTIONS TO CHANGE LIGHT SOURCE

STEP 1

To remove Alabaster Part:

1. With the accompanying allen key turn the screw clockwise until the Alabaster part can rotate
2. Take hold of the Alabaster part, then gently pull down, whilst slightly rotating

NOTE: When rotating the fixture choose the direction with the least resistance.

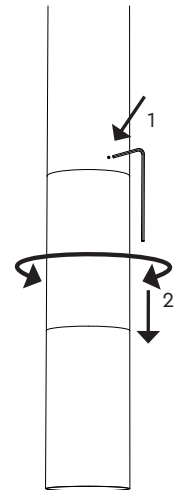

STEP 2

1. Turn the 3 screws anti-clockwise using the allen key.
2. Remove the retaining ring using light pressure.

Then replace the light source, reattach the retaining ring, make sure it snaps. Finally, fasten the 3 screws, so that they are flush with the fixture ring.

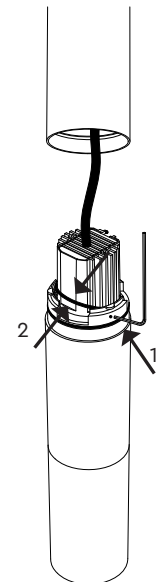

STEP 3

1. Remount the Alabaster part in the Tube, by gently rotating until the allen screw aligns with the hole in the Tube.
2. Secure the Alabaster part in place by turning the screw anti-clockwise until the screw is flush with the tube.

NOTE: When rotating the fixture choose the direction with the least resistance.

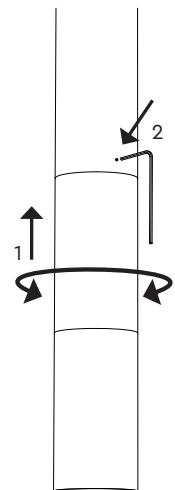

IMPORTANT INFORMATION

Installation and mounting must be performed by a certified electrician only, and instructions must be followed. Always make sure the main power is off during installation. Pay attention to the fixture remarks, and always make sure to use the correct voltage.

CLEANING AND MAINTENANCE:

Use a soft moist cloth for cleaning. No further maintenance is required.

WARRANTY:

If the product is defect, please contact your supplier immediately. Please note that warranty will not apply in case of wrongful use or if unskilled personnel attempts to repair.



The crossed-out wheeled bin symbol indicates that the item should be disposed of separately from household waste. The item should be handed in for recycling in accordance with local environmental regulations for waste disposal

For more information, please contact info@onea.dk

ASSEMBLY INSTRUCTION

Page 3 of 3

STEP 4

Lightly push in the honeycomb, thereby creating space to take hold of the Direct fixturing, then gently pull down.

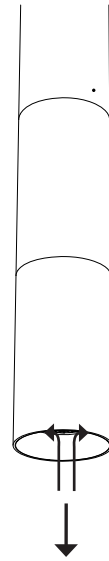

STEP 5

Remove the retaining ring using light pressure and replace the light source.

Reattach the retaining ring, make sure it snaps. Then remount the Direct in the Tube, by slightly rotating the Direct into place.

NOTE: When rotating the fixture choose the direction with the least resistance.

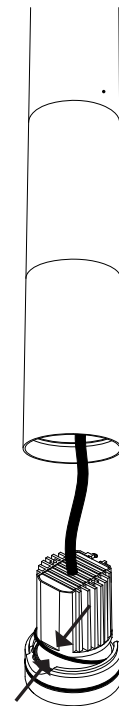

IMPORTANT INFORMATION

Installation and mounting must be performed by a certified electrician only, and instructions must be followed. Always make sure the main power is off during installation. Pay attention to the fixture remarks, and always make sure to use the correct voltage.

CLEANING AND MAINTENANCE:

Use a soft moist cloth for cleaning. No further maintenance is required.

WARRANTY:

If the product is defect, please contact your supplier immediately. Please note that warranty will not apply in case of wrongful use or if unskilled personnel attempts to repair.



The crossed-out wheeled bin symbol indicates that the item should be disposed of separately from household waste. The item should be handed in for recycling in accordance with local environmental regulations for waste disposal.

For more information, please contact info@onea.dk

DISASSEMBLY INSTRUCTION

STEP 1

Disconnect the cables

Please refer to Storm Output assembly instructions or other outlet

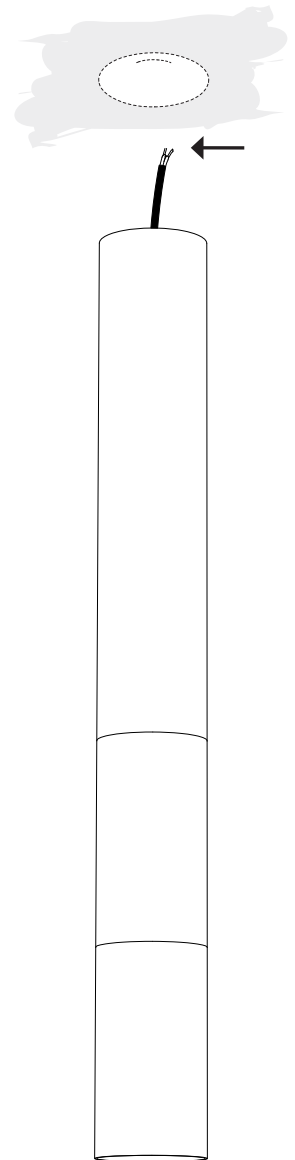

IMPORTANT INFORMATION

Installation and mounting must be performed by a certified electrician only, and instructions must be followed. Always make sure the main power is off during installation. Pay attention to the fixture remarks, and always make sure to use the correct voltage.

CLEANING AND MAINTENANCE:

Use a soft moist cloth for cleaning. No further maintenance is required.

WARRANTY:

If the product is defect, please contact your supplier immediately. Please note that warranty will not apply in case of wrongful use or if unskilled personnel attempts to repair.



The crossed-out wheeled bin symbol indicates that the item should be disposed of separately from household waste. The item should be handed in for recycling in accordance with local environmental regulations for waste disposal

For more information, please contact info@onea.dk