

ATOMIUM -DOT 14

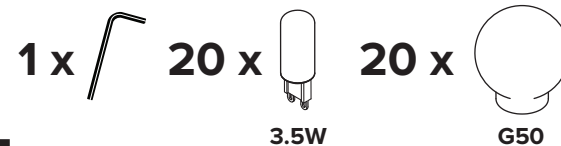

- To be installed by an electrician to an electrical box
- Use appropriate screws and anchors where necessary
- Wear enclosed gloves when handling lamp
- Handle materials with care. Please consult lamp maintenance sheet on our web site

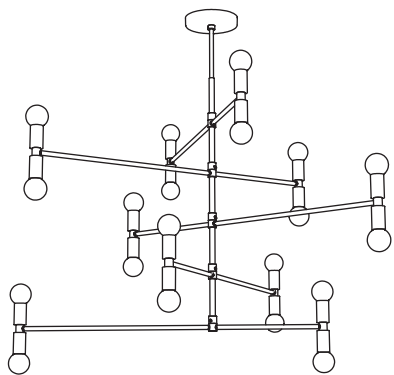

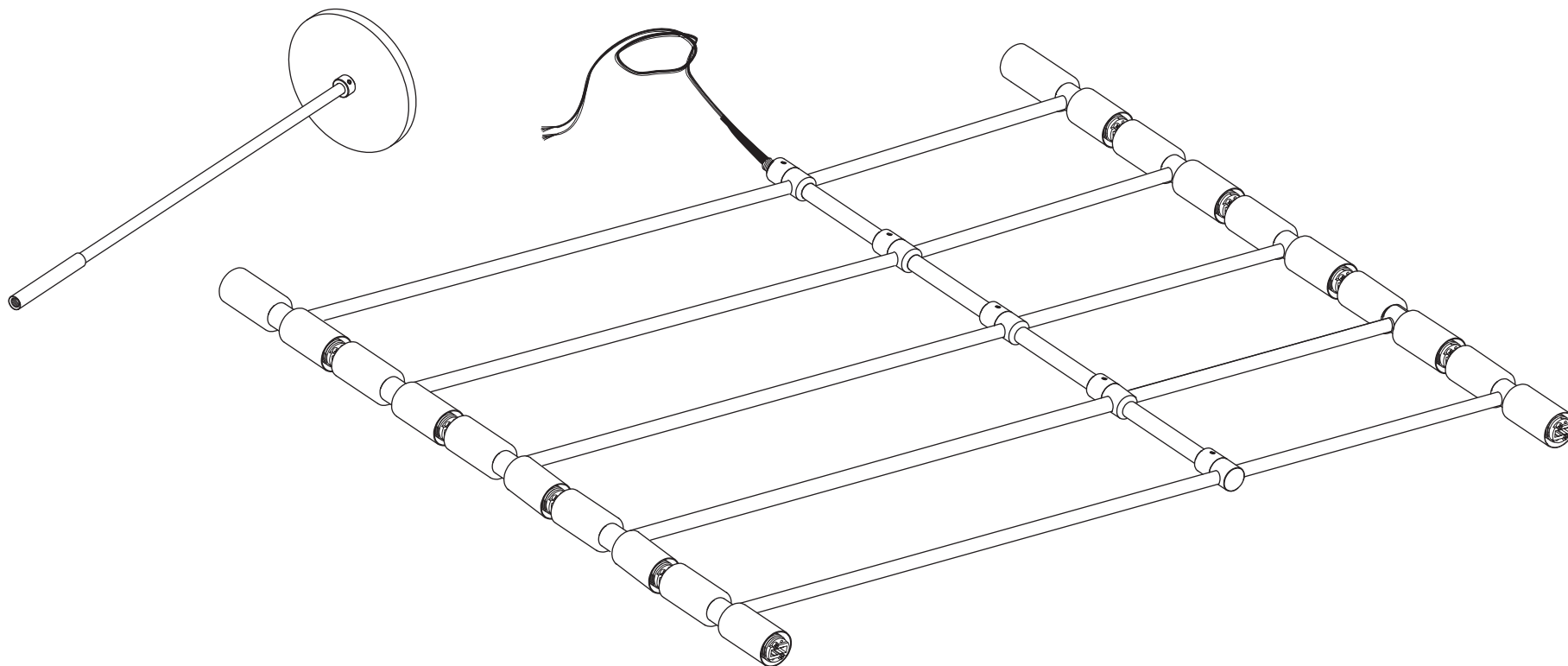

Important steps to follow when installing a glass globe

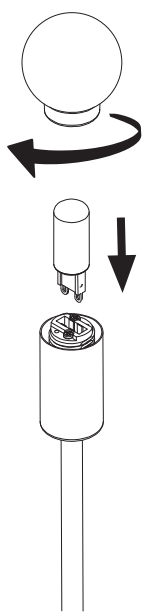

Insert bulb.

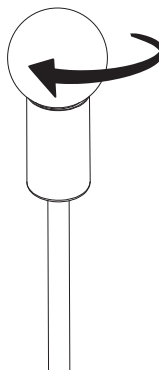

Screw in globe gently until it is tight.
Do not force the globe.

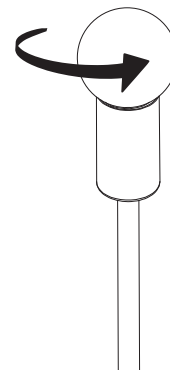

Unscrew bulb slightly 1/2 turn.

1

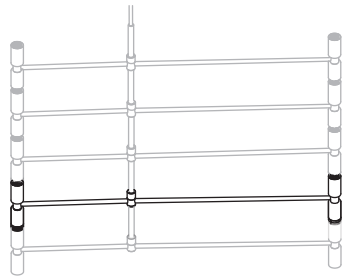

A

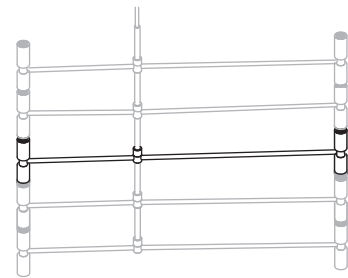

B

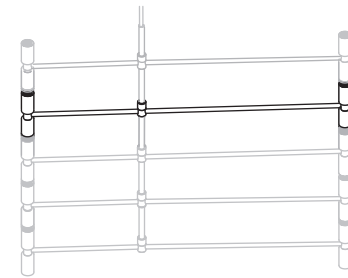

C

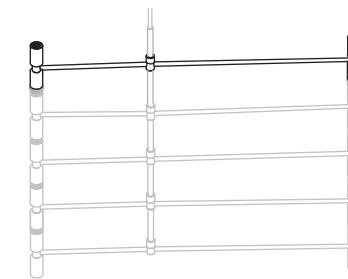

D

To ensure that your lamp is properly balanced, **PLEASE FOLLOW THESE STEPS CAREFULLY**

* Screw gently, but firmly

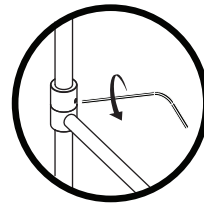

Loosen

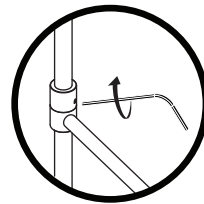

Tighten

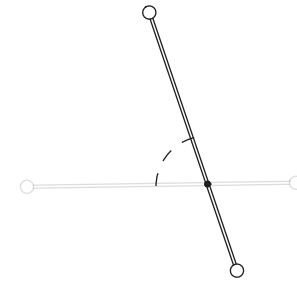

72°

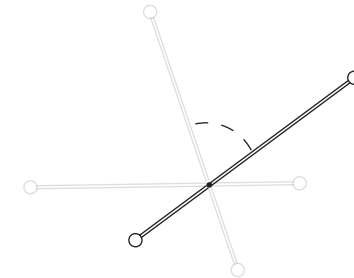

72°

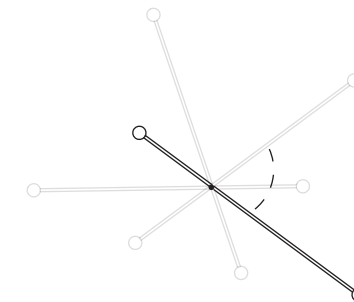

72°

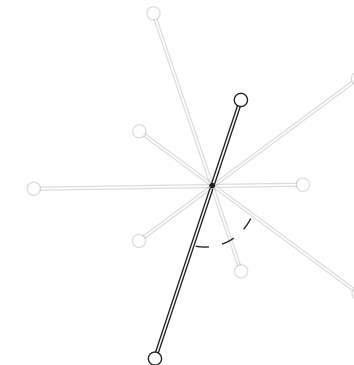

72°

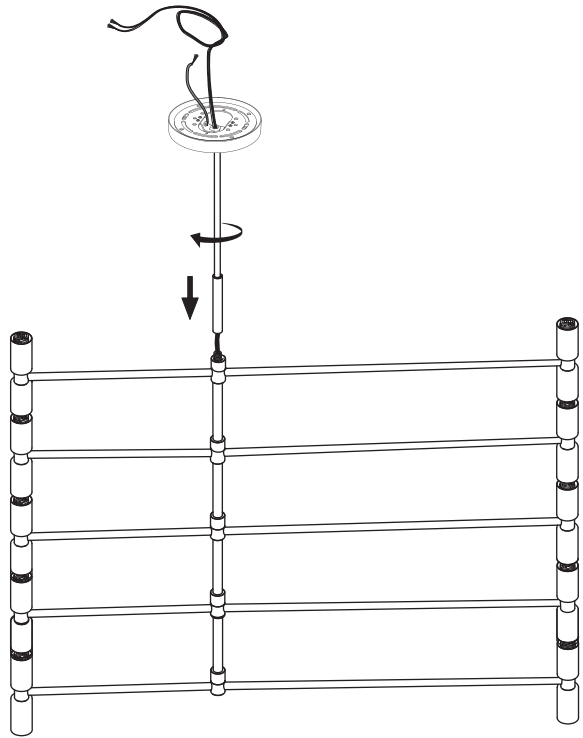

2

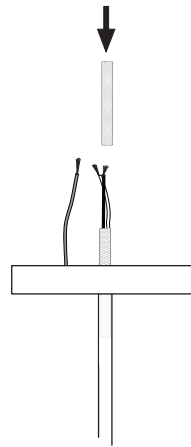

3

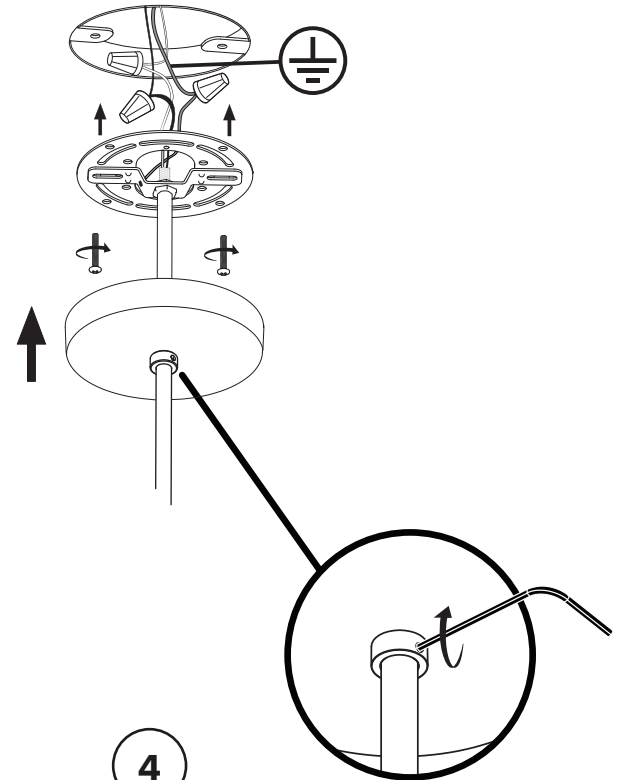

4

* Screw gently, but firmly

