

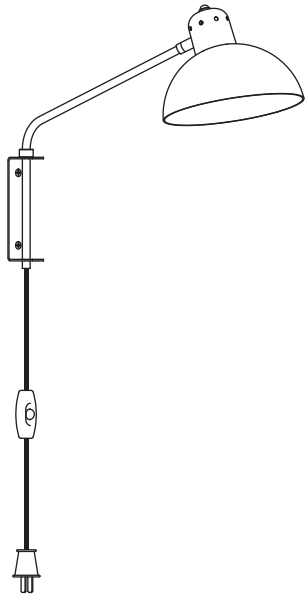

WALDORF WALL SMALL SOFTWARE

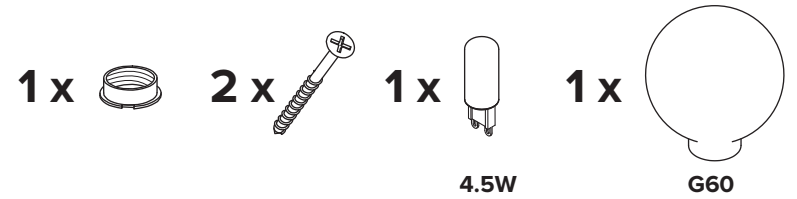

- 
- Use appropriate screws and anchors where necessary
 - Wear enclosed gloves when handling lamp
 - Handle materials with care. Please consult lamp maintenance sheet on our web site



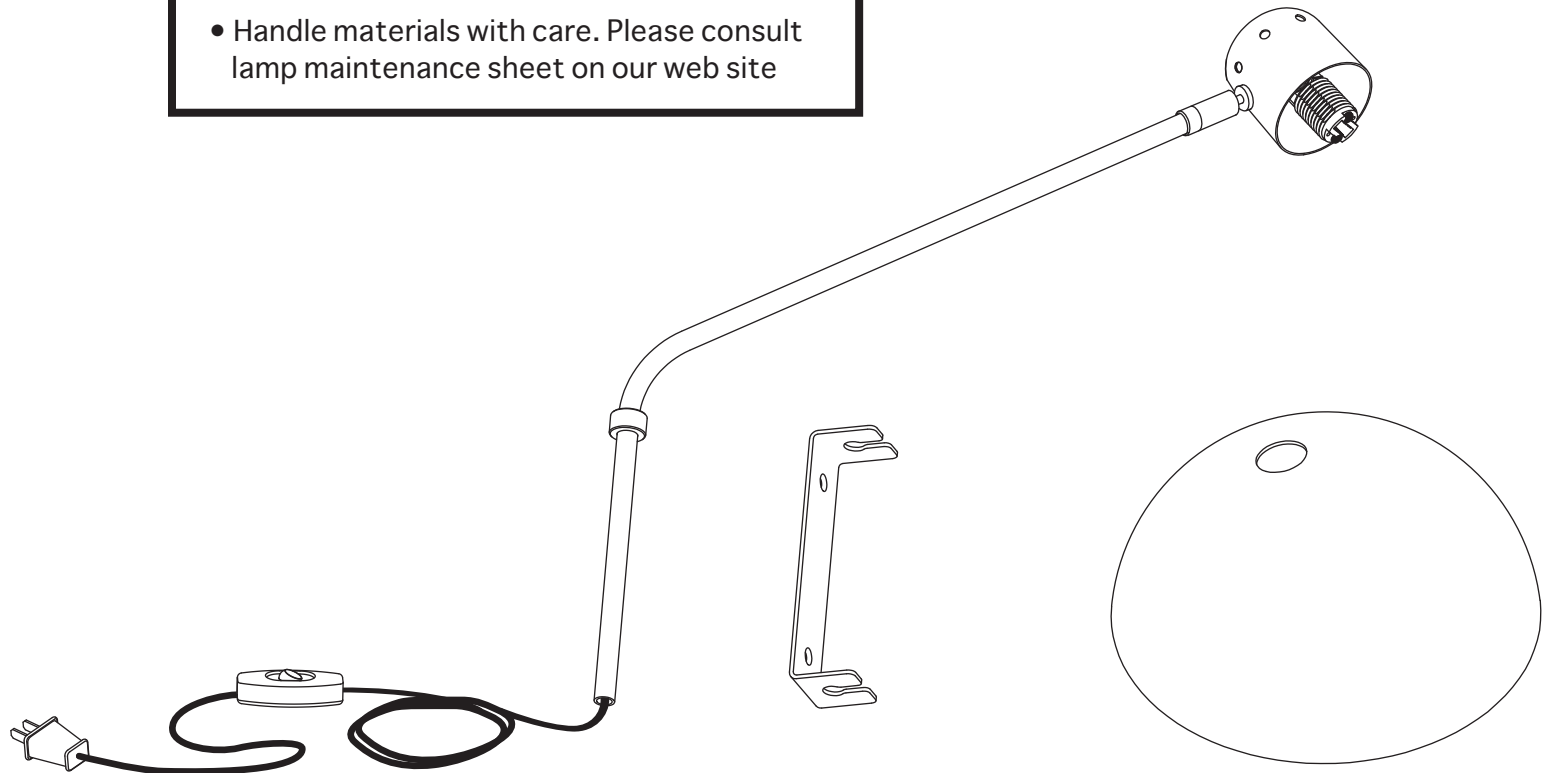

Important steps to follow when installing a glass globe

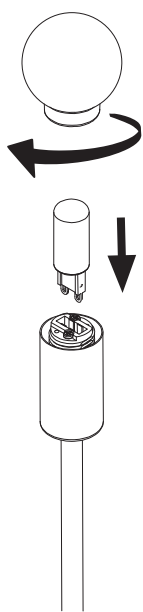

Insert bulb.

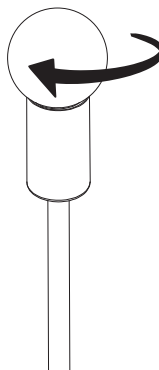

Screw in globe gently until it is tight.
Do not force the globe.

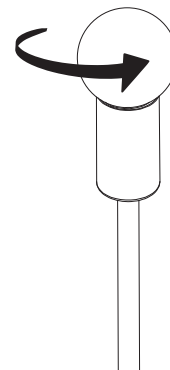

Unscrew bulb slightly 1/2 turn.



x

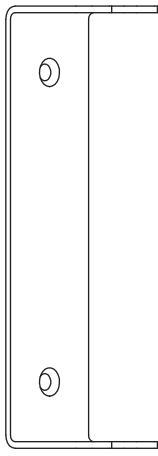

x

1



2

* Use appropriate anchors

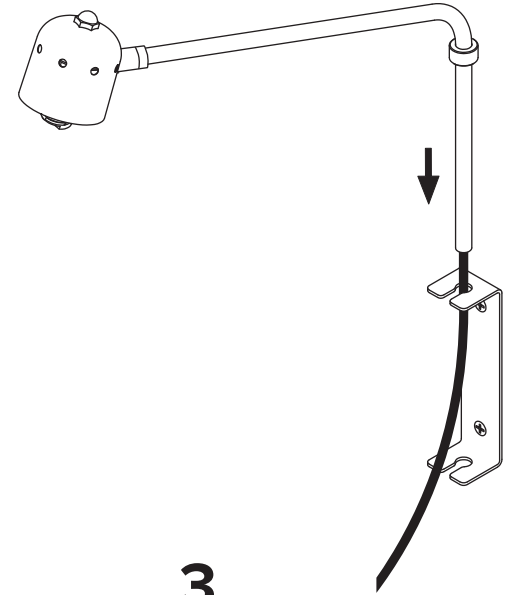
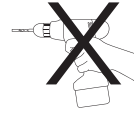
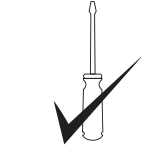

3

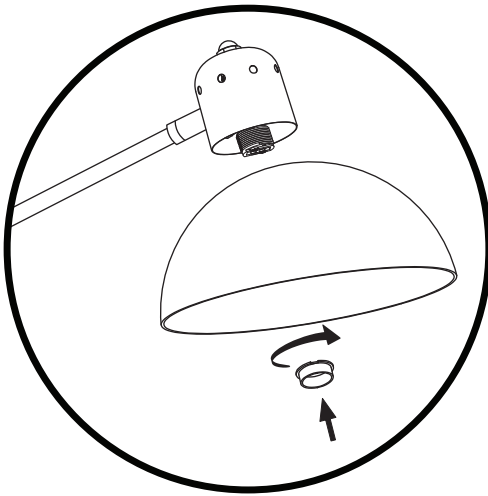

4

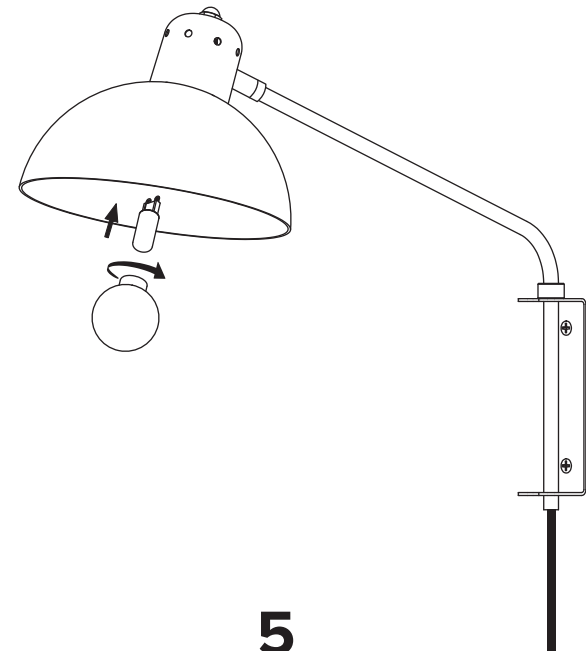

5

