

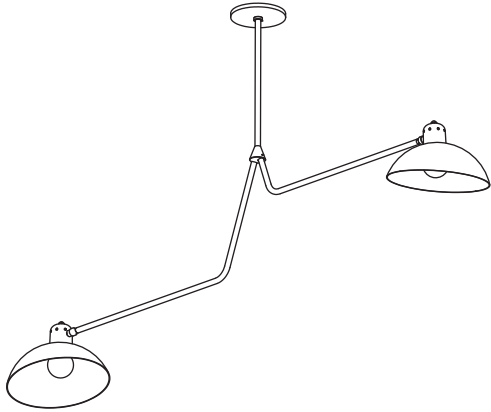

WALDORF DOUBLE

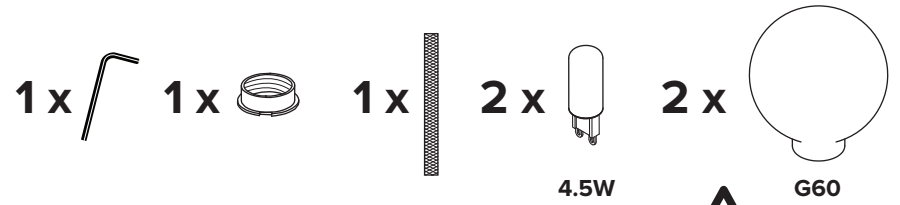

- 
- To be installed by an electrician to an electrical box
 - Use appropriate screws and anchors where necessary
 - Wear enclosed gloves when handling lamp
 - Handle materials with care. Please consult lamp maintenance sheet on our web site



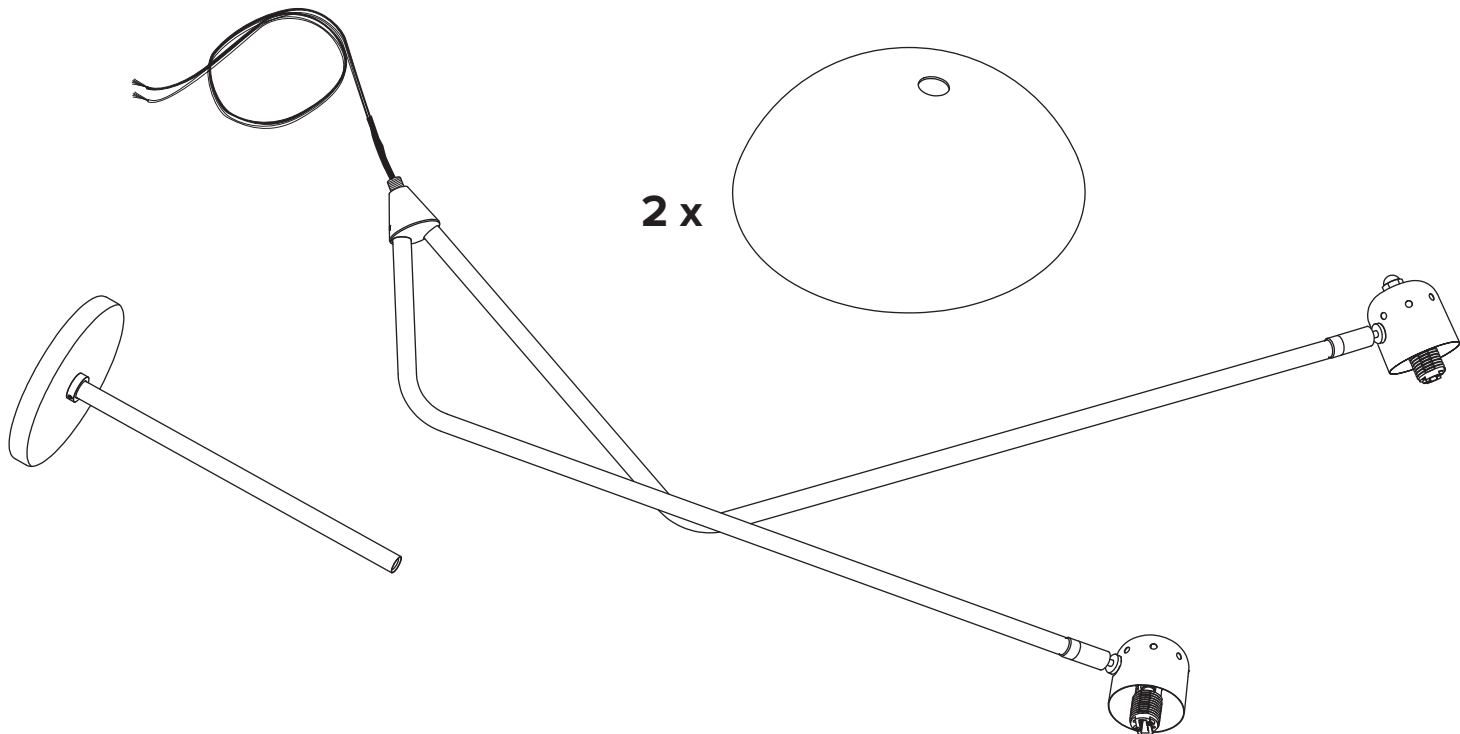

Important steps to follow when installing a glass globe

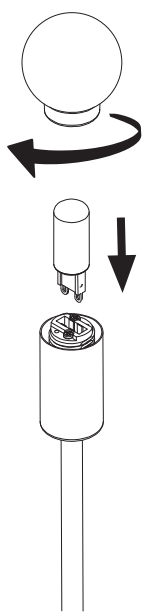

Insert bulb.

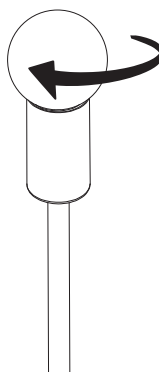

Screw in globe gently until it is tight.
Do not force the globe.

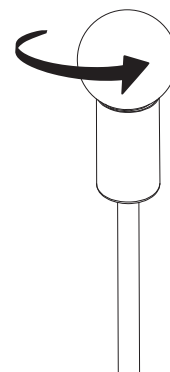

Unscrew bulb slightly 1/2 turn.

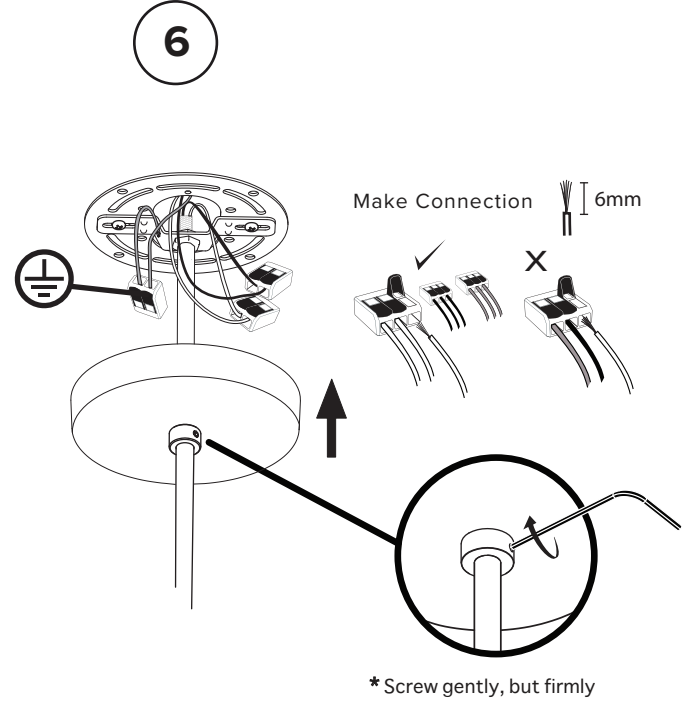
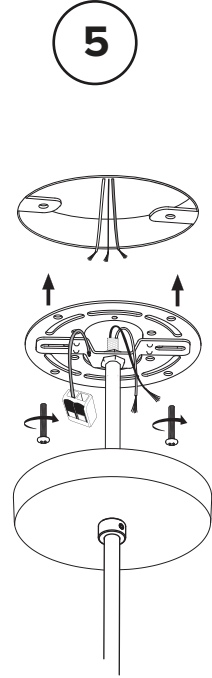
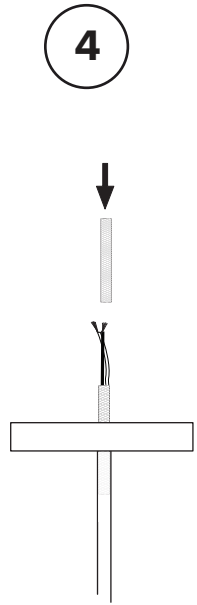
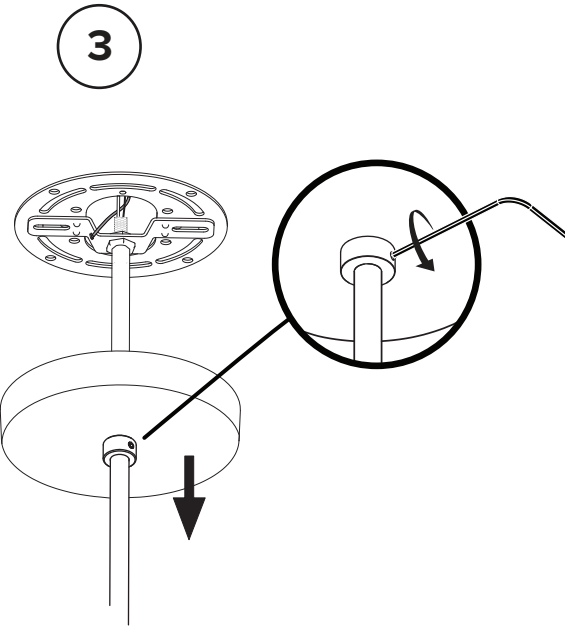
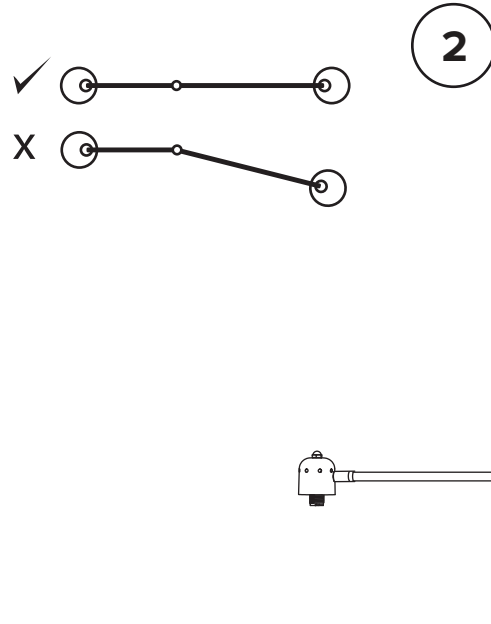
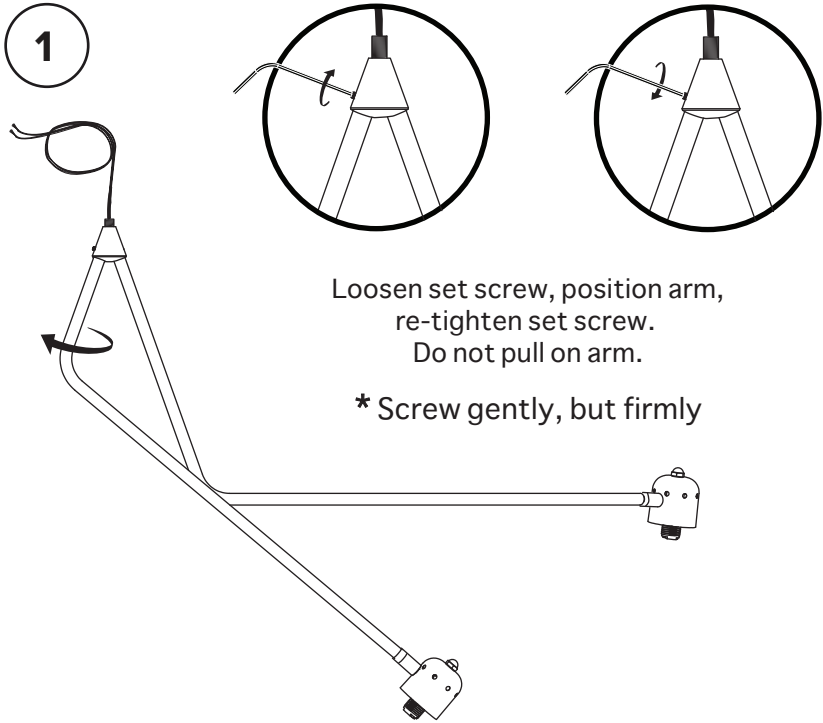

7

